

Basic

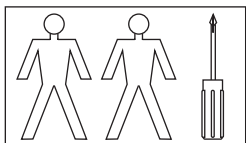

ver. L (levá / ľavá / stânga ver. R (pravá / cel potrivit

115,5cm x 190cm x 52,5cm

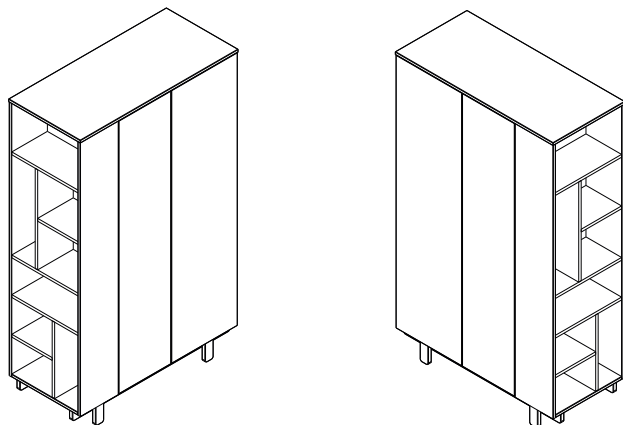
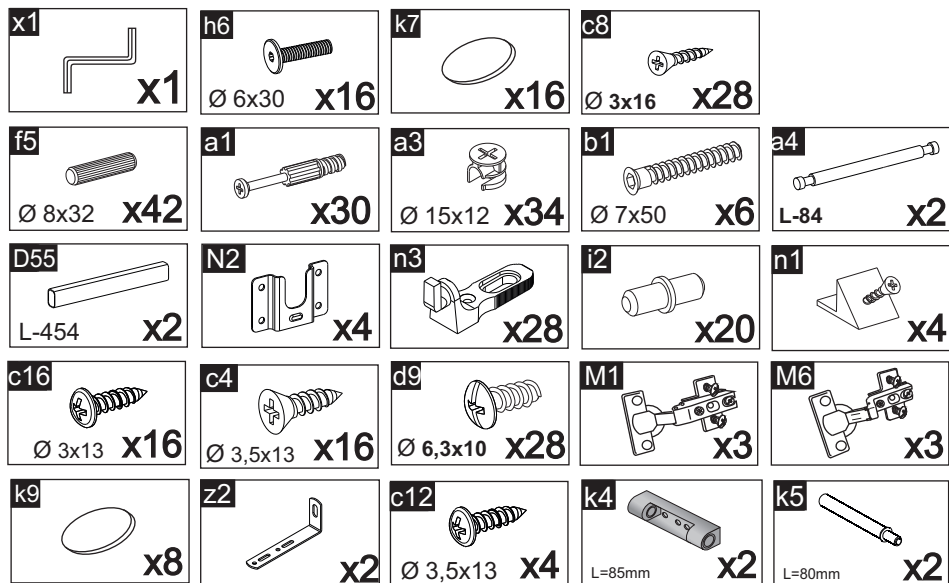

1/18

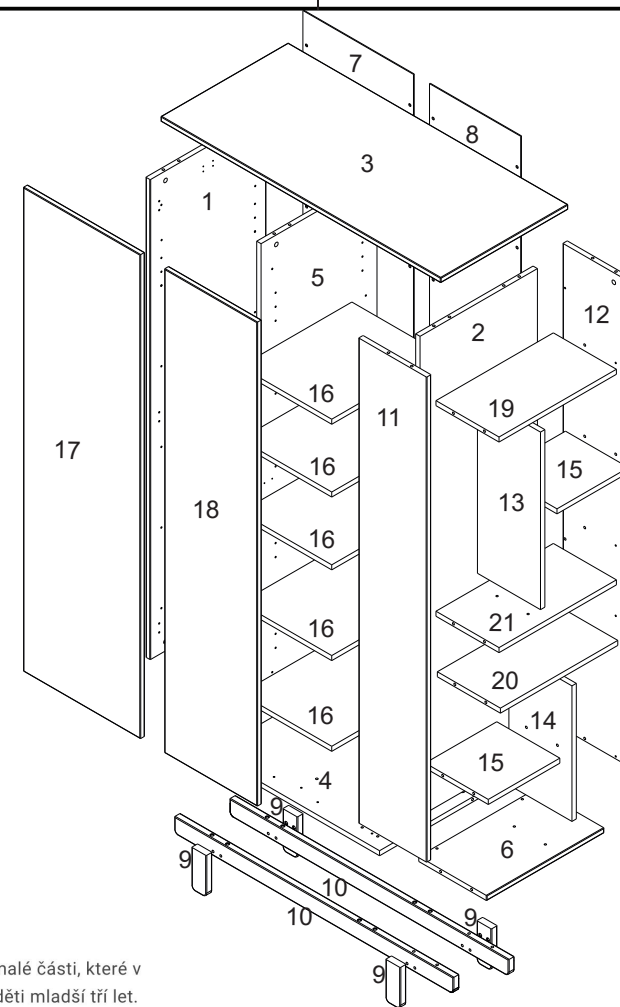
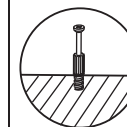
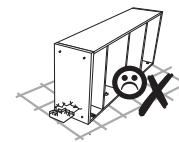
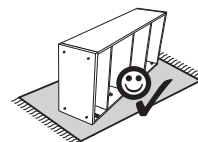

UPOZORNĚNÍ:

- Je nutné, aby výrobek sestavil dospělý.
- Při otevírání balení buďte opatrní - obsahuje malé části, které v rozloženém stavu představují nebezpečí pro děti mladší tří let.
- Nepoužívejte, pokud je některý konstrukční díl rozbitý nebo chybí, použijte pouze náhradní díly schválené výrobcem.
- Mějte na paměti riziko otevřeného ohně a jiných zdrojů silného tepla, např. elektrického topení, plynového ohně apod.
- Vždy postupujte podle pokynů výrobce.
- Pečlivě si přečtěte návod k sestavení a uschovejte ho k pozdějšímu použití.
- Veškeré změny provedené uživatelem musí být prováděny podle pokynů výrobce.
- Plastové sáčky a další obaly uchovávejte mimo dosah dětí.

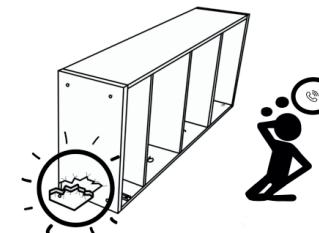

2/18

UPOZORNENIE:

- Je nutné, aby výrobok zostavil dospelý. Pri otváraní balenia buďte opatrní - obsahuje malé časti, ktoré v rozloženom stave predstavujú nebezpečenstvo pre deti do troch rokov.
- Nepoužívajte, pokiaľ je nejaký konštrukčný diel rozbitý alebo chýbajú, používajte iba schválené náhradné diely výrobcu.
- Majte na pamäti riziko otvoreného ohňa a iných zdrojov silného tepla, napr. elektrického kúrenia, plynového ohňa atď.
- Vždy postupujte podľa pokynov výrobcu.
- Starostlivo si prečítajte návod na zostavenie a uschovajte ho k neskoršiemu použitiu.
- Všetky zmeny vykonané užívateľom musia byť vykonávané podľa pokynov výrobcu
- Plastové sáčky a ďalšie obaly uchovávajte mimo dosahu detí.

ATENȚIE:

- Produsul trebuie asamblat de un adult. Aveți grijă la deschiderea ambalajului - conține părți mici care, atunci când sunt desfăcute, prezintă un pericol pentru copiii cu vârsta de sub trei ani.
- Nu utilizați dacă orice parte a acestuia este deteriorată sau lipsesc, utilizați numai piese de schimb aprobate de producător."
- Fiți conștienți de riscul de flăcări deschise și alte surse de căldură puternică, cum ar fi încălzitoare electrice, foc cu gaz, etc.
- Respectați întotdeauna sfaturile producătorului.
- Citiți cu atenție instrucțiunile de asamblare și păstrați-le pentru utilizarea în viitor.
- Toate modificările făcute de utilizator trebuie făcute conform instrucțiunilor producătorului
- Nu lăsați pungile de plastic și alte ambalaje la îndemâna copiilor.

| | | | | |
|-----------|-------------|----------|------------|------------|
| 1 | 1718 | x | 480 | 1.0 |
| 2 | 1718 | x | 488 | 1.0 |
| 3 | 1154 | x | 525 | 1.0 |
| 4 | 875 | x | 483 | 1.0 |
| 5 | 1718 | x | 482 | 1.0 |
| 6 | 488 | x | 283 | 1.0 |
| 7 | 1718 | x | 456 | 1.0 |
| 8 | 1718 | x | 376 | 1.0 |
| 9 | 150 | x | 60 | 4.0 |
| 10 | 1135 | x | 60 | 2.0 |
| 11 | 1732 | x | 280 | 1.0 |
| 12 | 1732 | x | 280 | 1.0 |
| 13 | 634 | x | 260 | 1.0 |
| 14 | 484 | x | 260 | 1.0 |
| 15 | 295 | x | 260 | 2.0 |
| 16 | 377 | x | 460 | 5.0 |
| 17 | 1728 | x | 482 | 1.0 |
| 18 | 1728 | x | 382 | 1.0 |
| 19 | 484 | x | 260 | 1.0 |
| 20 | 484 | x | 260 | 1.0 |
| 21 | 484 | x | 260 | 1.0 |

1

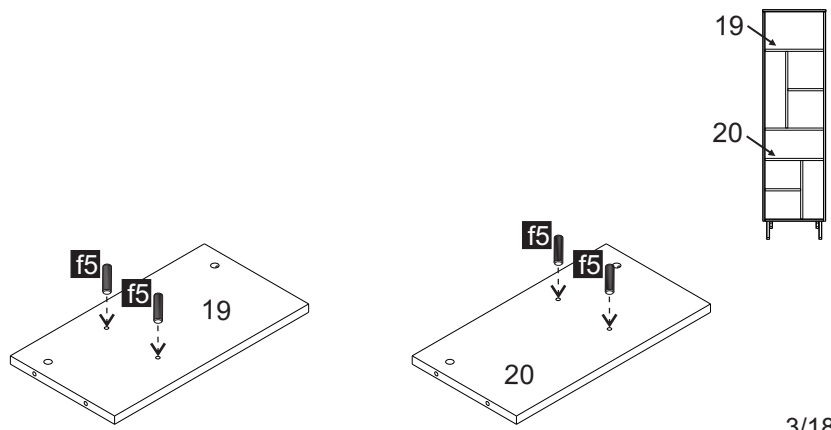
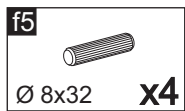

2

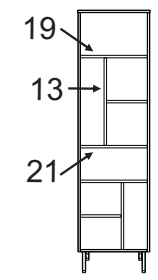
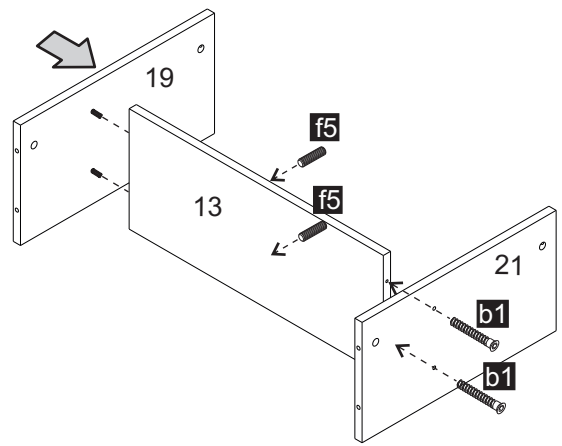
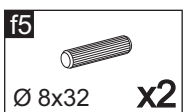
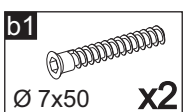

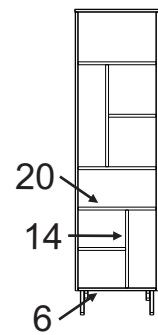
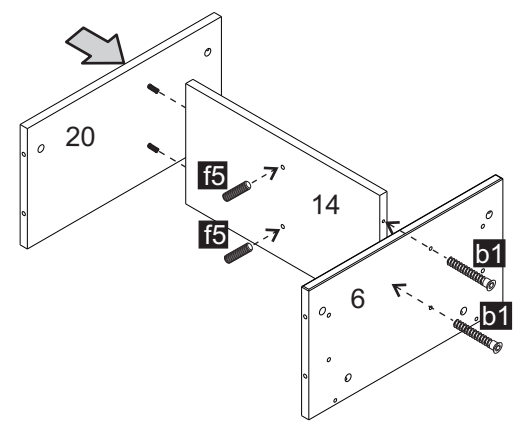
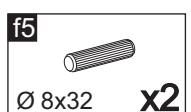
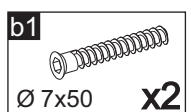

3

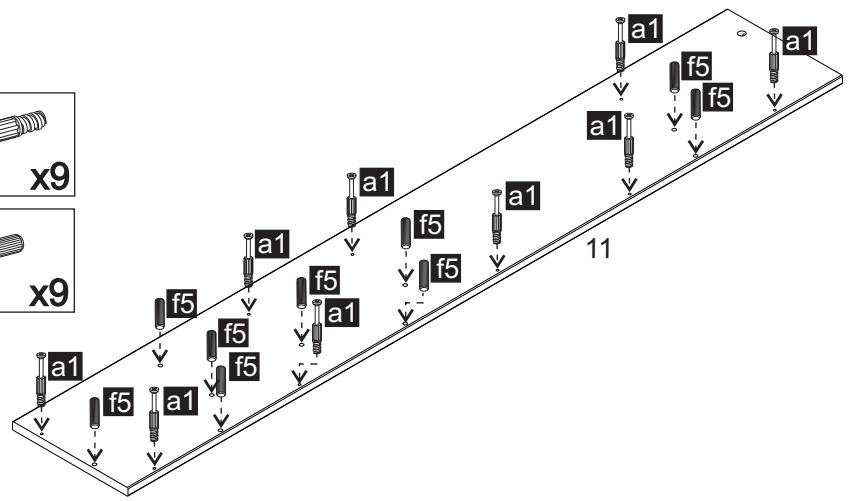
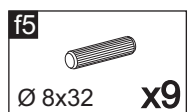
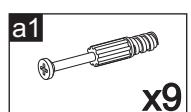

4



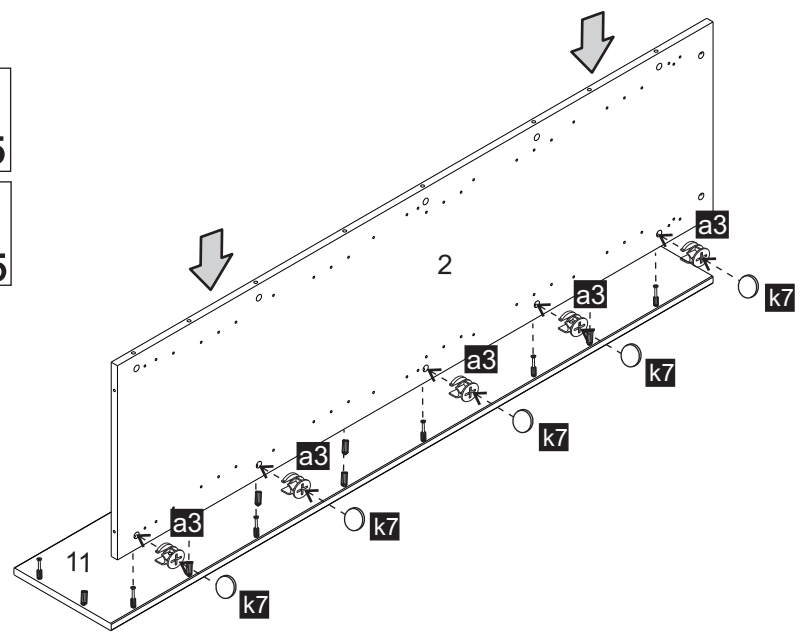

5

- a3**  $\varnothing 15 \times 12$ x5
- k7**  x5

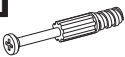

7

- a1**  x9
- f5**  $\varnothing 8 \times 32$ x9

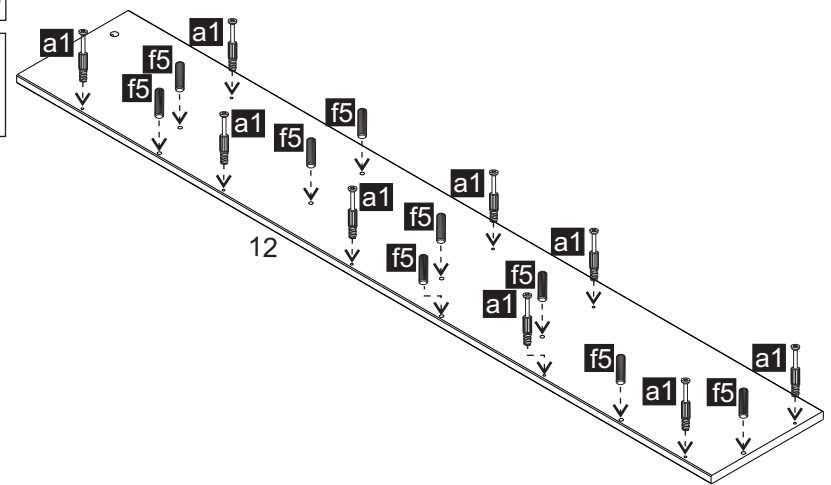

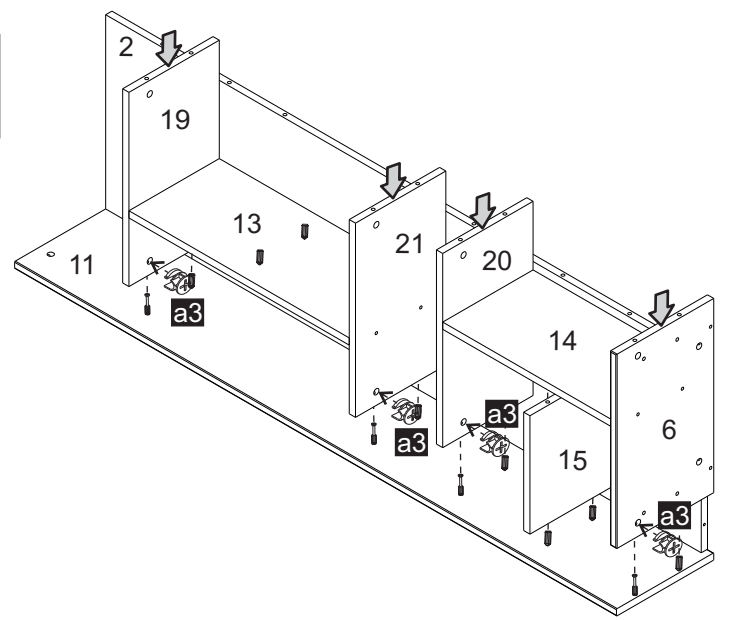

6

- a3**  $\varnothing 15 \times 12$ x4

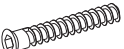

8

- b1**  $\varnothing 7 \times 50$ x2
- a3**  $\varnothing 15 \times 12$ x4

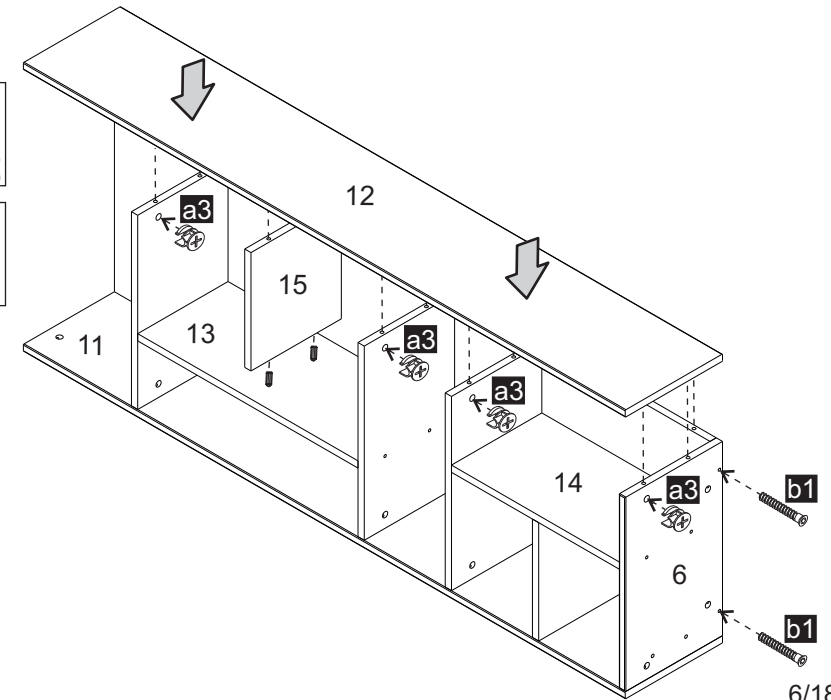

9

a3
Ø 15x12 x9

a4
L-84 x2

k7 x5

k9 x2

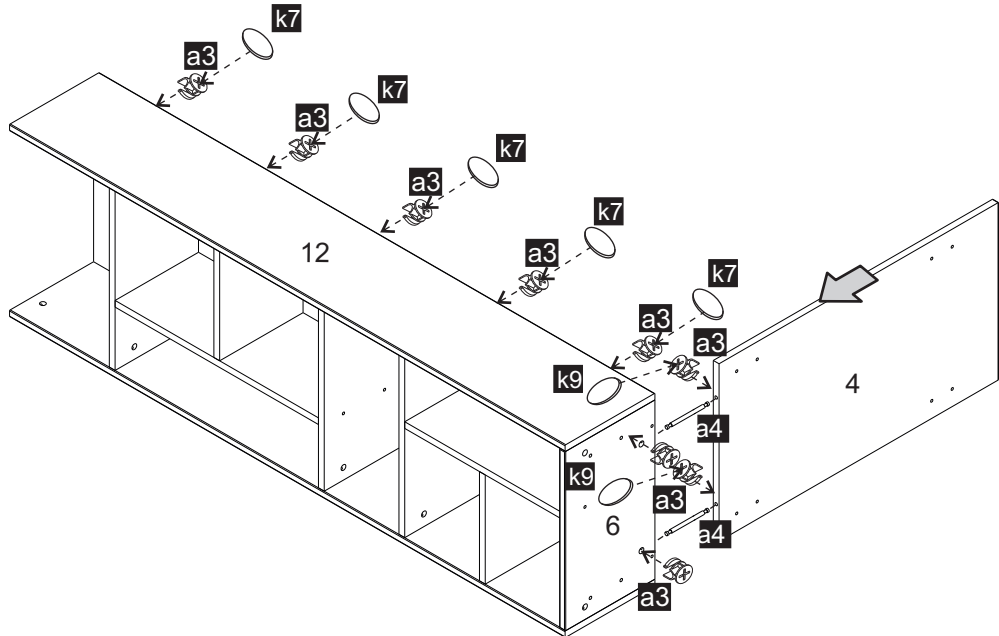

11

h6
Ø 6x30 x8

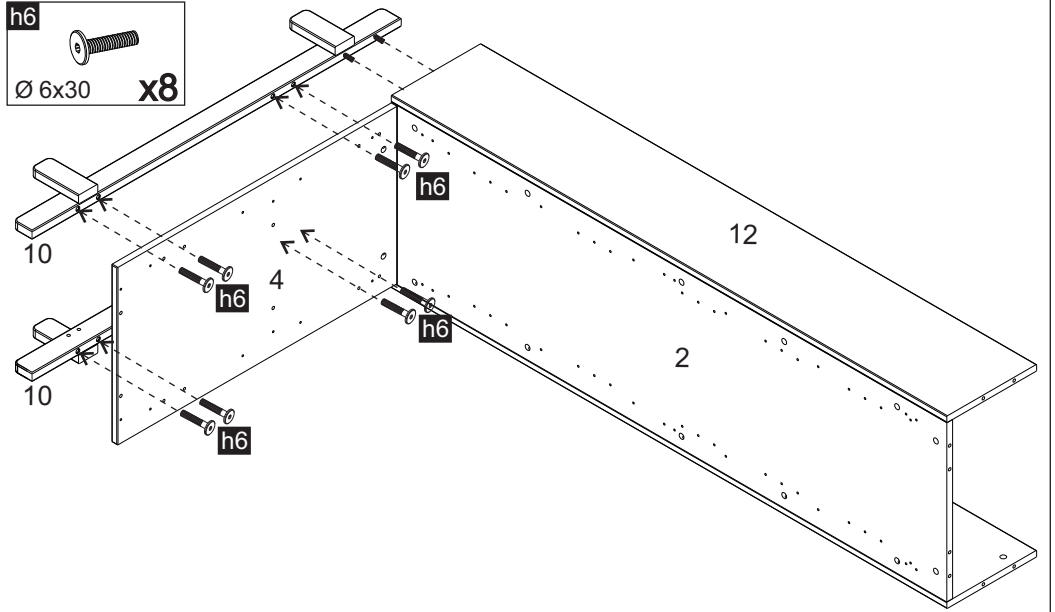

10

f5
Ø 8x32 x4

h6
Ø 6x30 x8

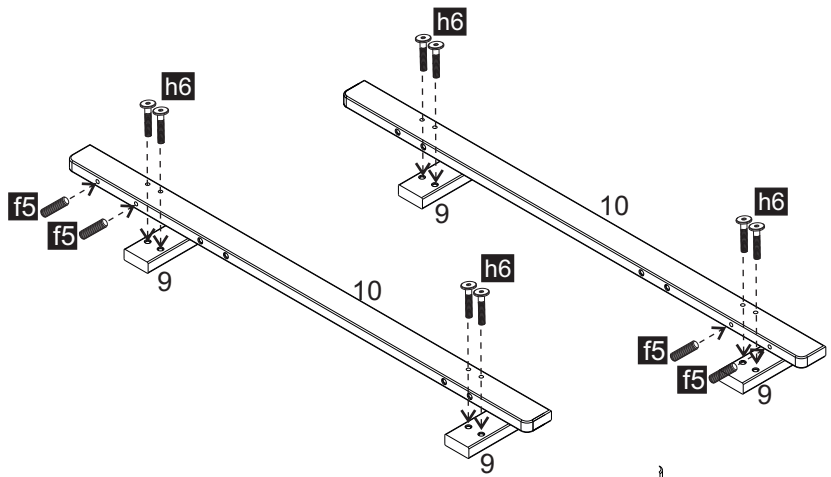

12

a1 x4

f5
Ø 8x32 x4

i2 x10

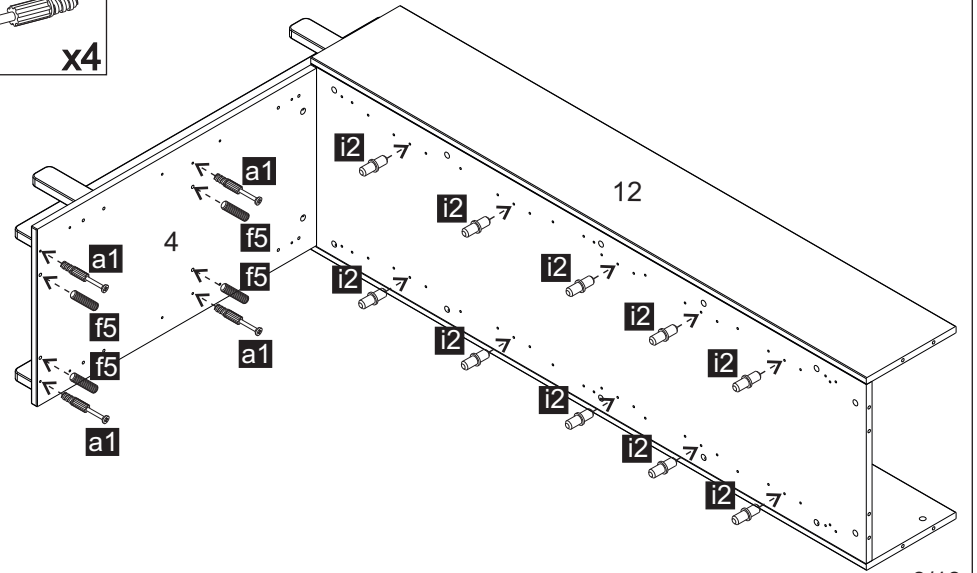

13

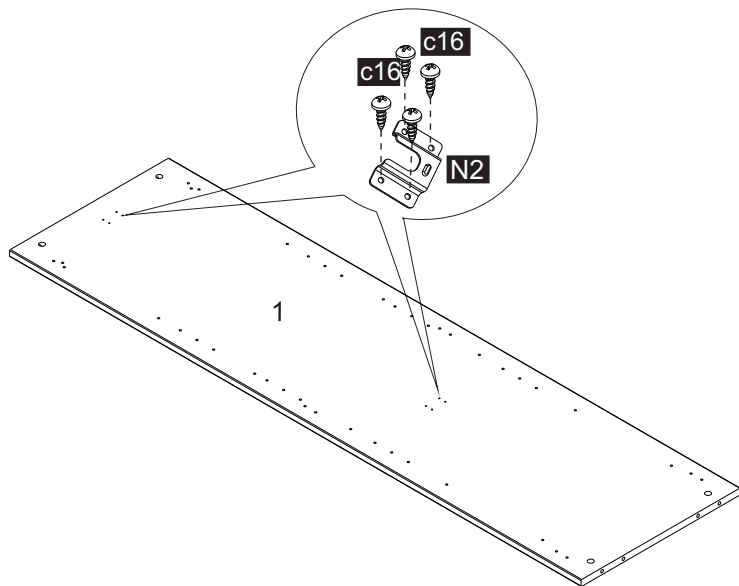
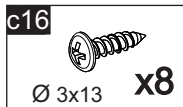
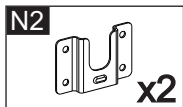

15

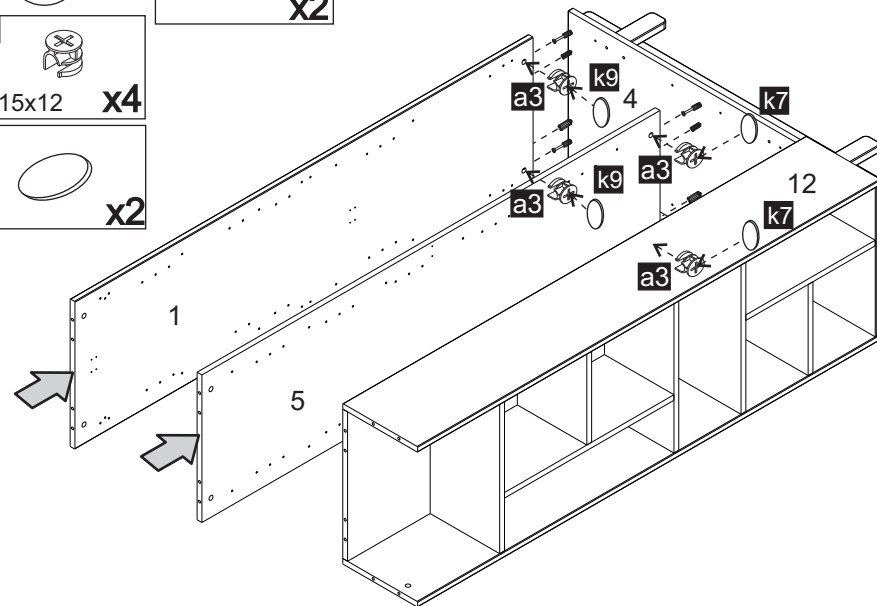
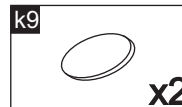
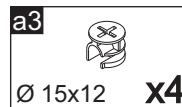
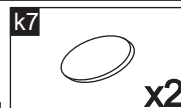

14

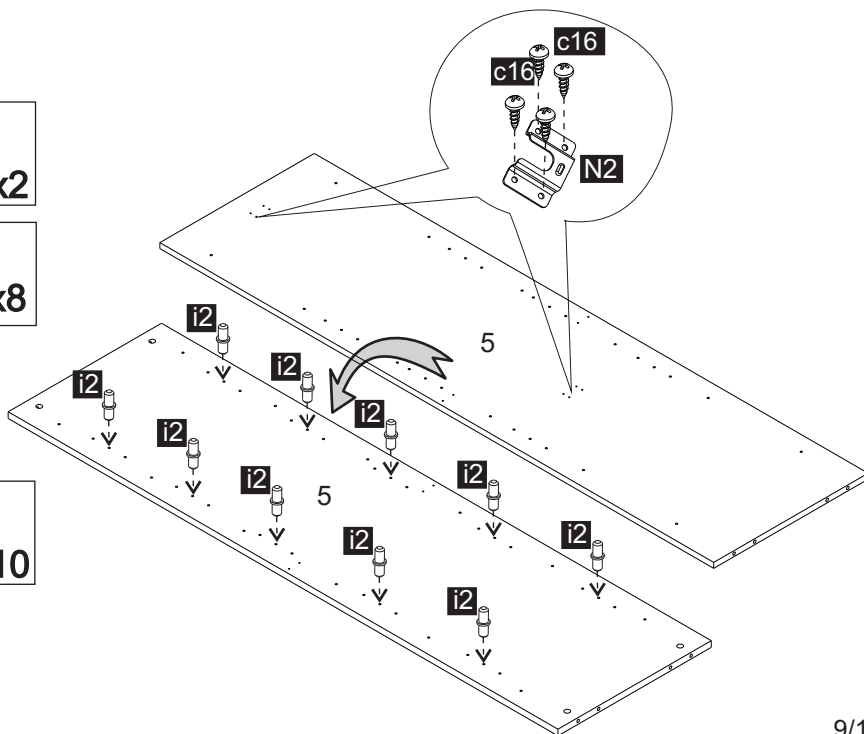
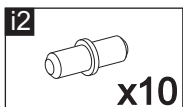
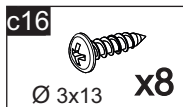
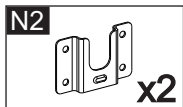

16

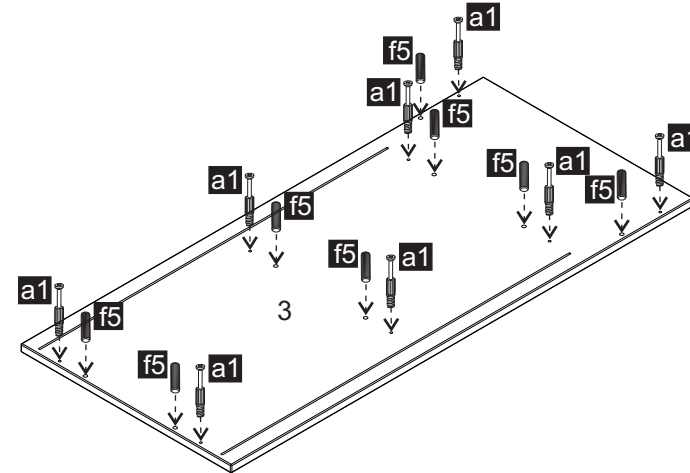
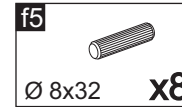
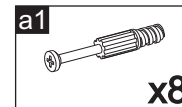

17

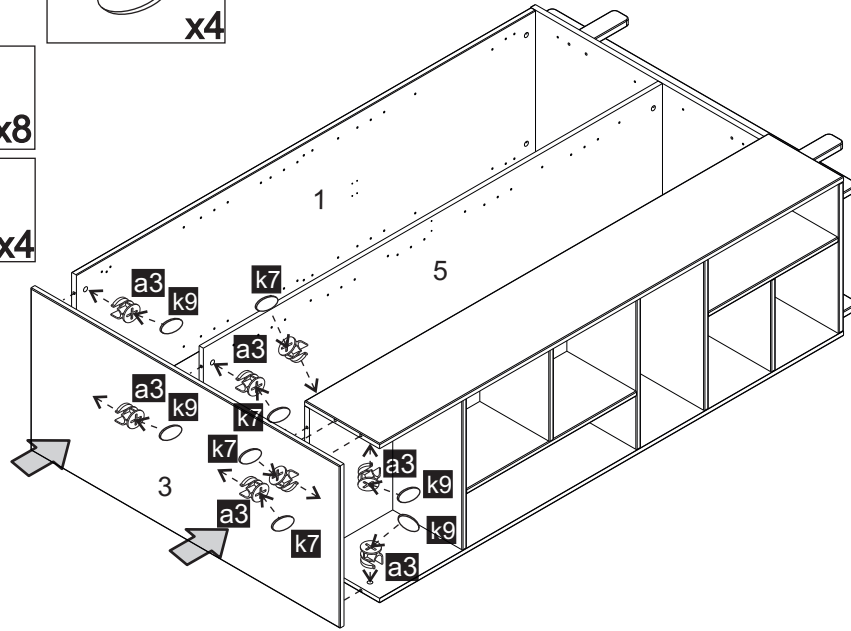
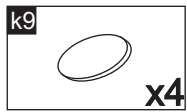
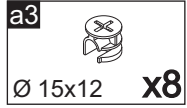
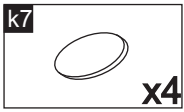

18b

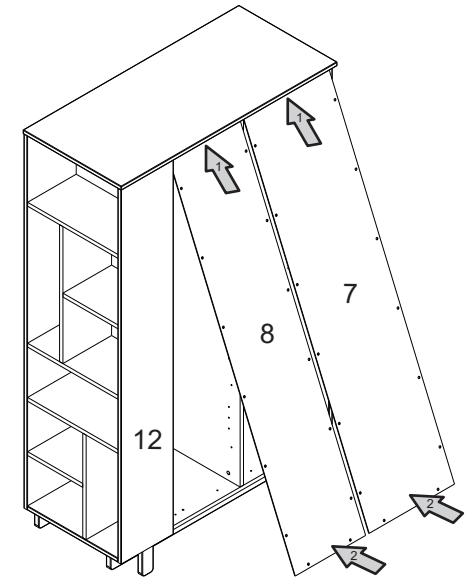
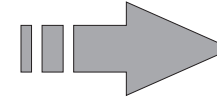
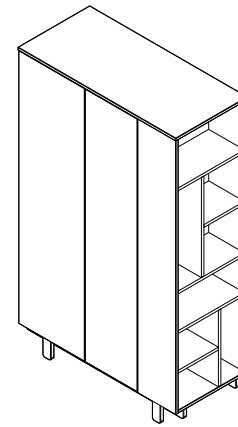

ver. R (pravá / cel potrvit)

18a

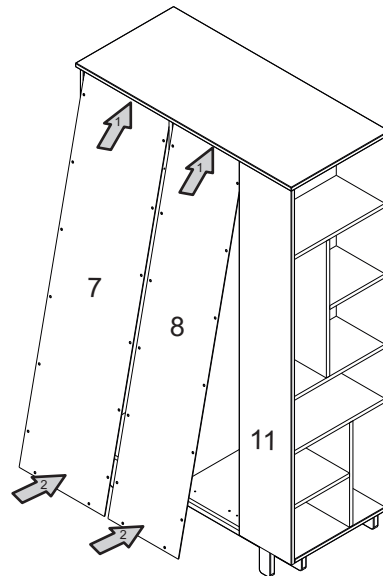
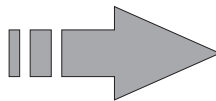
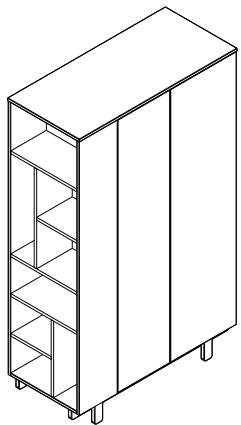

ver. L (levá / ľavá / stânga)

19

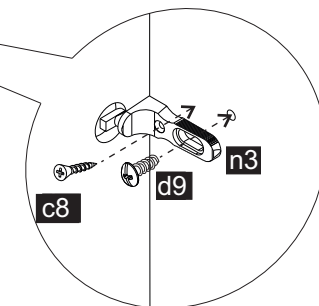
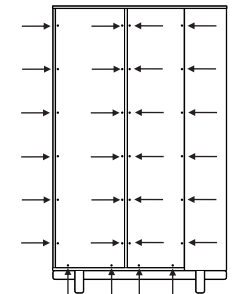
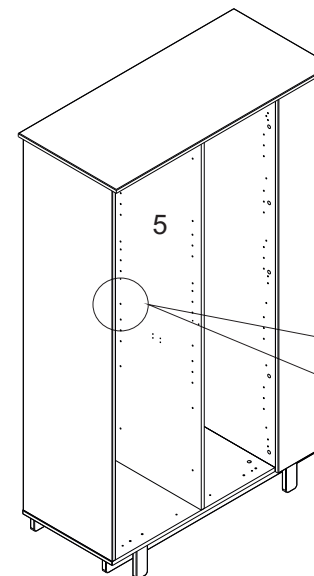
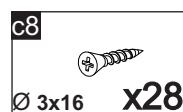
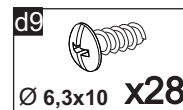
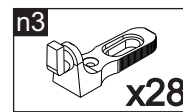

20

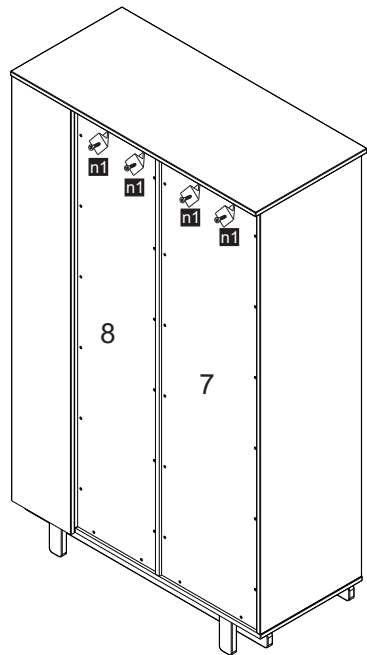
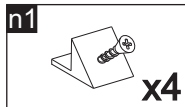

22 x3

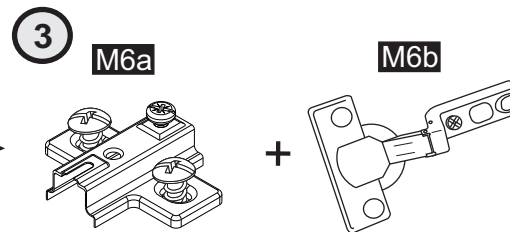
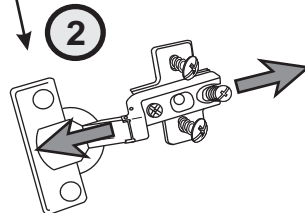
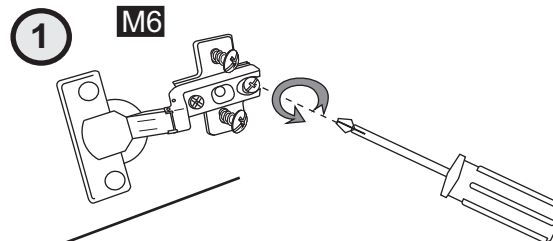
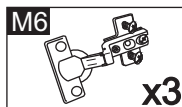

21

L+R

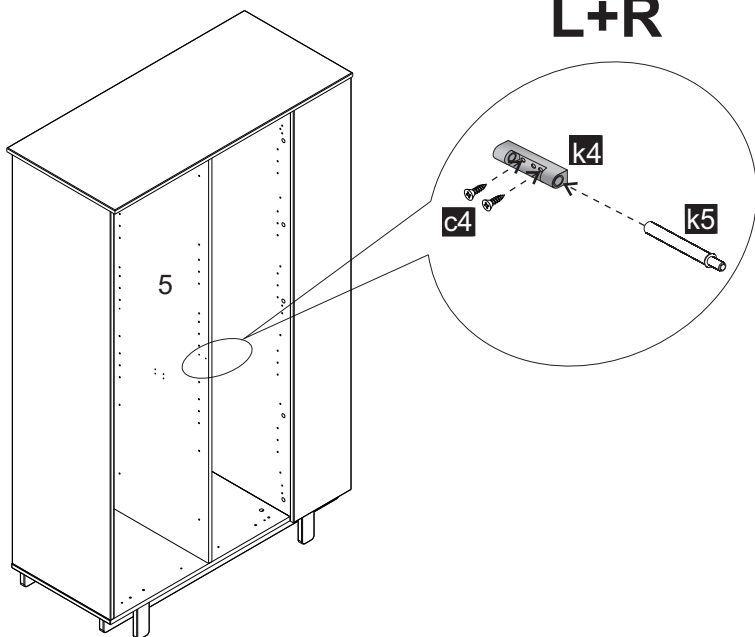
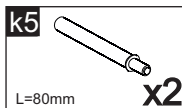
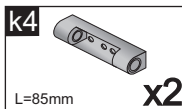
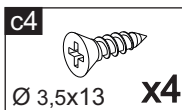

23 x3

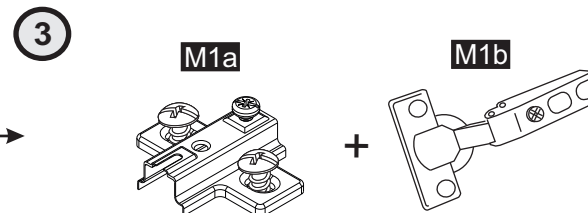
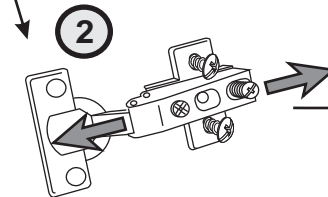
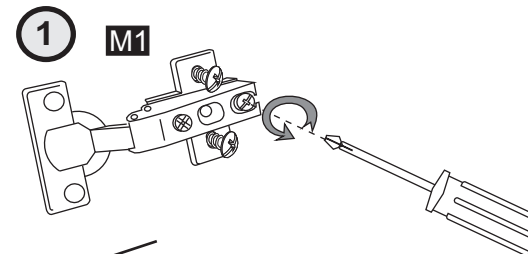
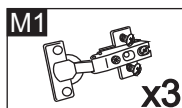

24

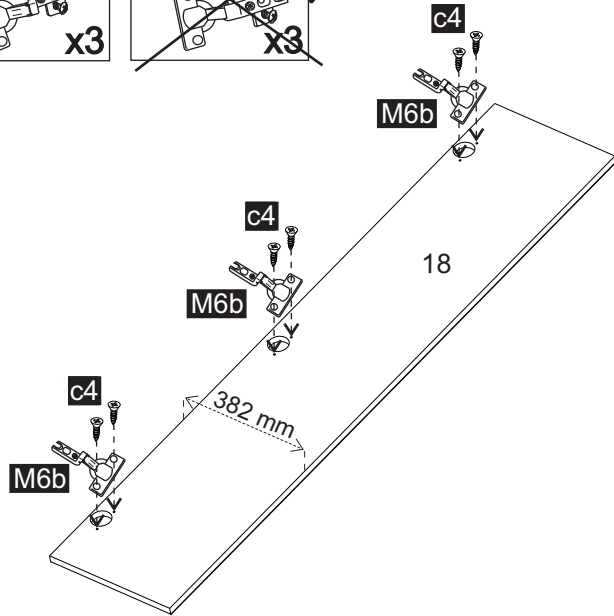
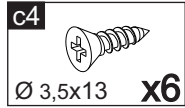
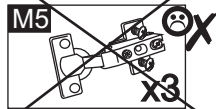
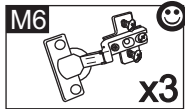
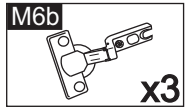

24

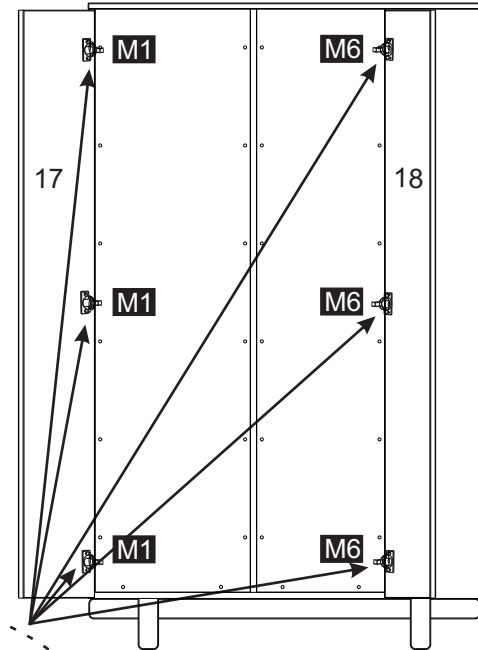
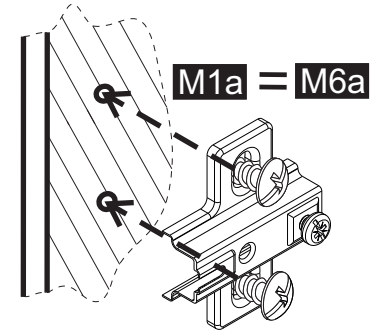
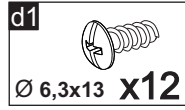
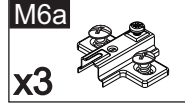
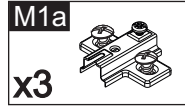

25

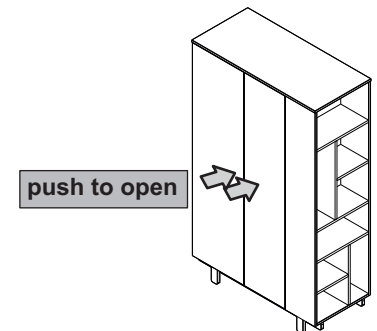
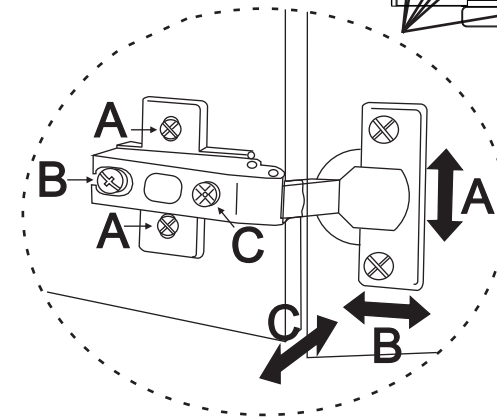
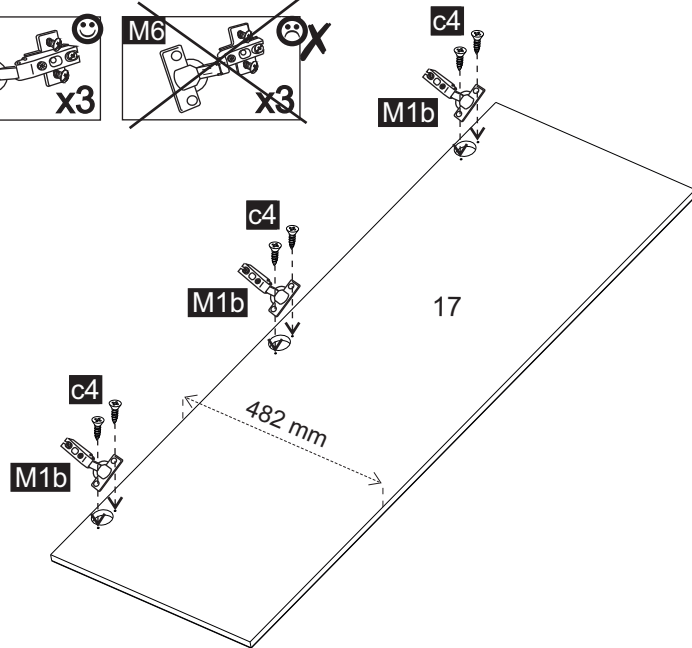
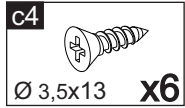
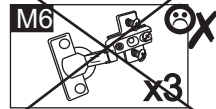
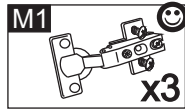
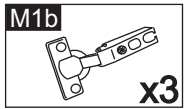

25

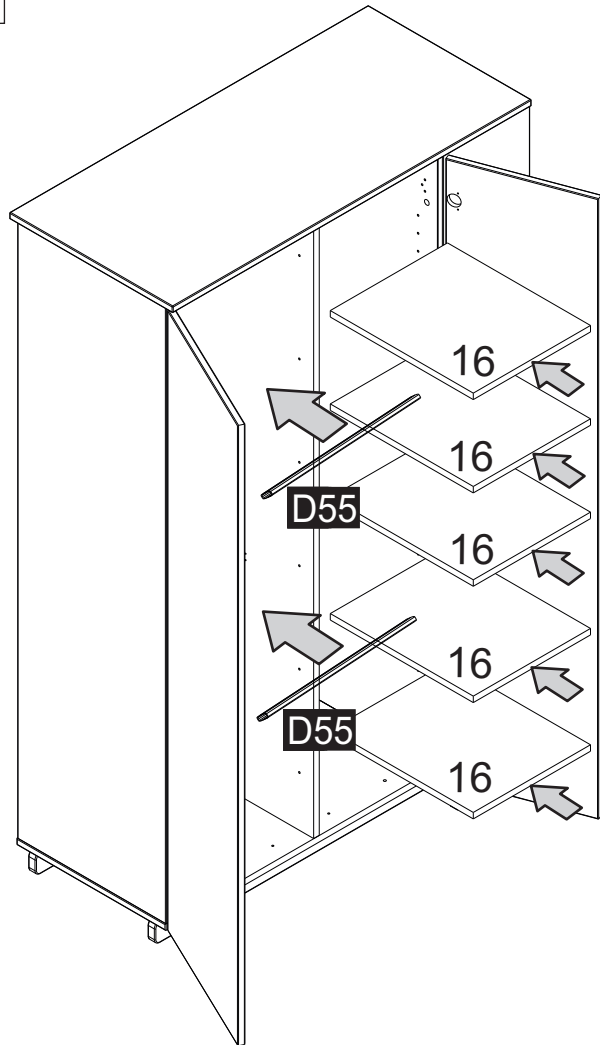
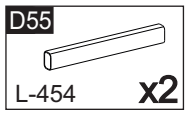

27

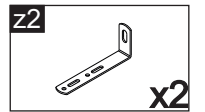
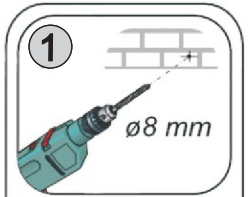
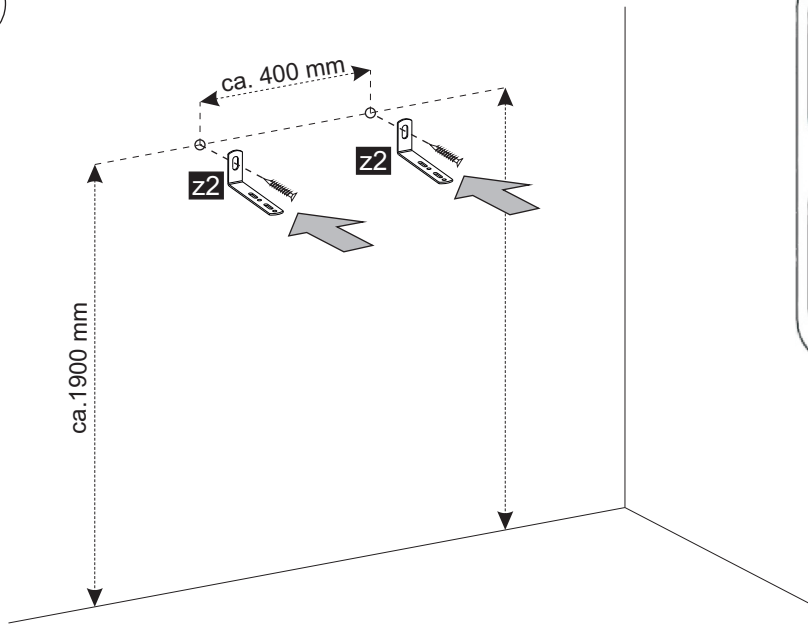

28

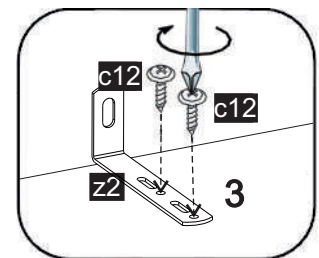
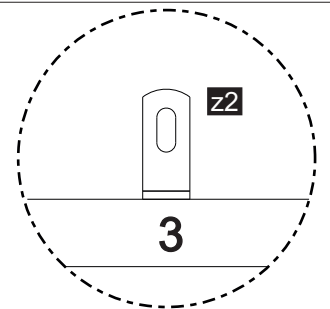
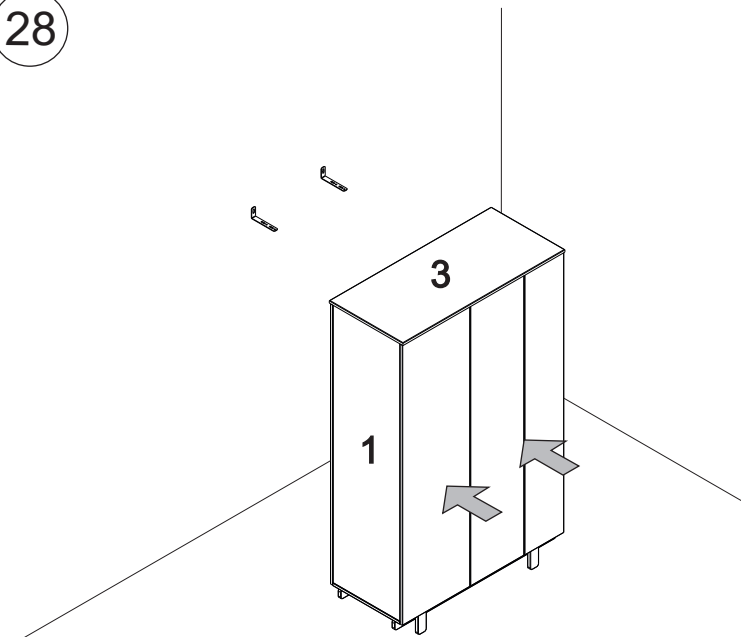

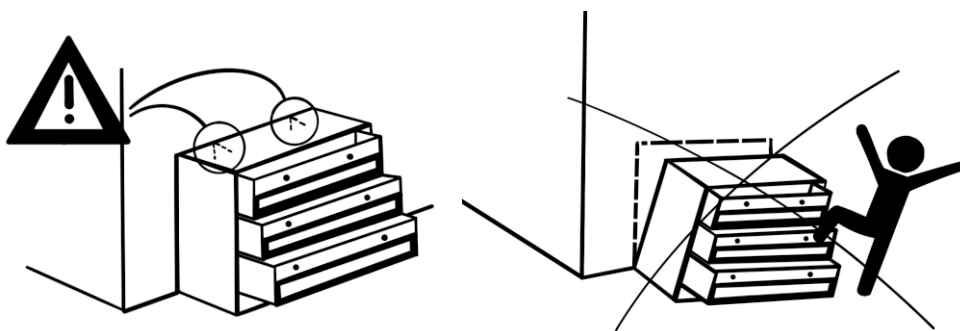

Upevněte ho!

Všichni chceme, aby naše domovy byly bezpečné.

Nejlepší způsob, jak zabránit pádu kusu nábytku, je připevnit jej ke stěně.

Jak předejít nehodám způsobeným převrácením nábytku? Upevněte ho!

Nábytek by měl být bezpečně připevněn ke stěně.

Nedovolte dětem lézt nebo věšet se na nábytku.

Upevněte ho! Návod pro montáž na stěnu. Nábytek by měl být bezpečně připevněn ke stěně. Vzhledem k různým typům stěn si zvolíte typ uchycení na stěnu. Pokud není níže uveden materiál, ze kterého jsou stěny u vás vyrobeny nebo máte doplňující dotazy, obraťte se na vybranou prodejnu se stavebninami.

Stavební materiál

1. Sádrokartonová nebo sádrokartonová stěna s dřevěným rámem- obr.1

2. Sádrokartonová stěna bez dřevěného rámu- obr.2

3. Cihlová zed:

- pevná stěna (obr. 3a)

- stěna s prázdným prostorem uvnitř (obr. 3b)

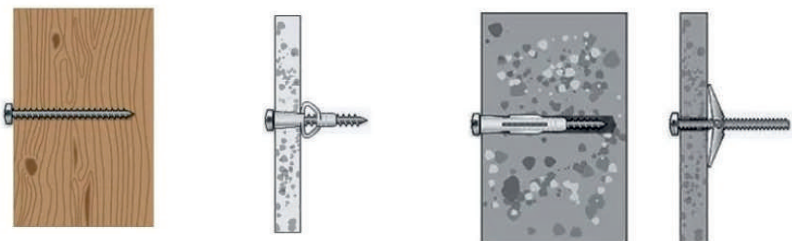

Upevnite ho!

Všetci chceme, aby naše domovy boli bezpečné.

Najlepší spôsob, ako zabrániť pádu kusu nábytku, je pripevniť ho k stene.

Ako predísť nehodám spôsobeným prevrácením nábytku? Upevnite ho!

Nábytok by mal byť bezpečne pripevnený k stene.

Nedovoľte deťom liezť alebo vešať sa na nábytku.

Upevnite ho! Návod na montáž na stenu. Nábytok by mal byť bezpečne pripevnený k stene. Vzhľadom k rôznym typom stien si zvolíte typ uchytenia

na stenu. Pokiaľ nie je nižšie uvedený materiál, z ktorého sú steny u vás vyrobené alebo máte doplňujúce otázky, obráťte sa na vybranú predajňu so stavebninami.

Stavebný materiál

1. Sadrokartónová alebo sadrokartónová stena s dreveným rámom- obr.1

2. Sadrokartónová stena bez dreveného rámu- obr.2

3. Tehlový múr:

- pevná stena (obr. 3a)

- stena s prázdny m priestorom vo vnútri (obr. 3b)

Remediați-I!

Cu toții ne dorim ca casele noastre să fie în siguranță.

Cel mai bun mod de a preveni căderea unei piese de mobilier este fixarea acesteia de perete.

Cum să preveniți accidentele cauzate de răsturnarea mobilierului?

Remediați-I!

Mobilierul trebuie fixat ferm pe perete.

Nu permiteți copiilor să se cațere sau să atârne de mobilier.

Remediați-I! Instrucțiuni pentru montarea pe perete. Mobilierul trebuie să fie în siguranță atasat de perete. Datorita diferitelor tipuri de pereti, alegeți tipul de atasament pe perete. Dacă materialul din care sunt făcuți pereții dvs. nu este listat mai jos sau dacă aveți întrebări suplimentare, vă rugăm să contactați magazinul selectat cu materiale de construcție.

Material de construcție

1. Perete de gips-carton sau gips-carton cu rama din lemn - fig.1

2. Perete din gips-carton fără cadru din lemn - fig.2

3. Zid de cărămidă:

- perete solid (Fig. 3a)

- un perete cu un spațiu gol în interior (Fig. 3b)